

Vetralla 2

VE2-N-xx-NO / VE2-N-xx-OF

victoria  albert®

volcanic limestone baths



Contemporary double-ended tub

- Made from ENGLISHCAST™
 - One piece casting of Volcanic Limestone™ and resin
 - Harder & more durable than acrylic
- Easy clean high gloss finish
- Exterior can be painted
- 25 year warranty
- Available in six standard paint finishes, or explore our spectrum of new RAL colors in gloss or matte finishes



Baignoire moderne à double assise

- Fabriquée en ENGLISHCAST™
 - Ensemble d'une pièce en pierre volcanique rare et résine
 - Matériau plus dur et plus résistant que l'acrylique
- Fini ultra brillant, facile à nettoyer
- L'extérieur peut être peint
- Garantie de 25 ans
- Disponible en six finitions de peinture standard. Nous vous proposons également une palette de nouvelles couleurs RAL en finition brillante ou mate

* ENGLISHCAST™ white products only. Paint finish exterior warranty for 2 years.

* Uniquement pour les produits en ENGLISHCAST™ blanc. Pour les finitions extérieures peintes la garantie est de 2 ans.

* Solo sobre productos en ENGLISHCAST™ blanco. Acabados de pintura exterior tienen una garantía de 2 años



Bañera contemporánea con doble espalda

- Hecho de ENGLISHCAST™
 - Hecho en una pieza de piedra volcánica y resina
 - Más resistente y duradero que acrílico
- Fácil de limpiar y acabado brillante
- El exterior se puede pintar
- 25 años de garantía
- Disponible en seis acabados de pintura estándar. También puede consultar nuestra nueva gama de colores RAL en acabados brillo y mate

25
years

Warranty for residential use for 25 years*
25 ans de garantie pour un usage domestique*
Garantía de 25 años para uso domestico*

8
years

Warranty for commercial use for 8 years*
8 ans de garantie pour un usage commercial*
Garantía de 8 años para uso comercial*

Vetralla 2

VE2-N-xx-NO / VE2-N-xx-OF

victoria + albert®

volcanic limestone baths

Special Options/Options spéciales/Opciones especiales



External finish

Use codes on right to determine SKU. The colors shown here are not exact representations.

Utiliser le code à droite pour déterminer la référence produit. La couleur présentée n'est pas la nuance réelle.

Utiliza el código a la derecha para determinar el SKU. Los colores presentados aquí, pueden variar a la realidad.



VE2-N-SW-xx



VE2-N-MW-xx



VE2-N-BK-xx



VE2-N-GR-xx



VE2-N-MB-xx



VE2-N-AN-xx



VE2-N-SG-xx

SW ENGLISHCAST™ White / ENGLISHCAST™ blanc / ENGLISHCAST™ blanco

MW Matte white / Blanc mat / Blanco mate

BK Gloss black / Noir brillant / Negro brillante

GR Light gray / Gris clair / Gris claro

MB Matte black / Noir mat / Negro mate

AN Anthracite / Gris anthracite / Antracita

SG Stone gray / Gris pierre / Gris piedra

RAL colors



Also available in a spectrum of new RAL colors in gloss or matte finishes. For more information visit www.vandabaths.com.

Egalement disponible dans toute une palette de nouvelles couleurs RAL pour les finitions brillantes ou mates. Pour davantage d'informations, rendez-vous sur www.vandabaths.com.

También disponible en una gama de colores RAL Nuevos, con acabados en brillo o mate. Para más información, visite www.vandabaths.com.

Overflow

Available with or without an overflow hole. The new Kit 36/40 'intelli-waste' (pending IAPMO approval) offers proven flood protection without an unsightly overflow hole.

Disponible avec ou sans trou de trop-plein. Le nouveau Kit 36/40 intelligent (en cours d'approbation par l'IAPMO) offre une protection homologuée contre les débordements, et ce, sans trou de trop-plein disgracieux.

Disponible con o sin agujero rebosadero. El nuevo Kit 36/40 "intelli waste" (pendiente certificación IAPMO) ofrece una protección aprobada contra rebosar la bañera sin un agujero rebosadero.



VE2-N-xx-NO

No overflow hole
Sans trop-plein
Sin agujero rebosadero



VE2-N-xx-OF

Overflow hole
Avec trop-plein
Con agujero rebosadero



K-36D / K-40D



K-36S / K-40S



Recommended: K36/K40/K51

Conseillé / Recomendado



K51

Related collections

Collections connexes / Colecciones relacionadas



ios 54



Tubo faucet - TU-14

www.vandabaths.com

VA/1181/06/Feb19



Massachusetts Code: Approved
cUPC listing by IAPMO: File No. 6574

Vetralla 2

VE2-N-xx-NO / VE2-N-xx-OF



volcanic limestone baths

Top view

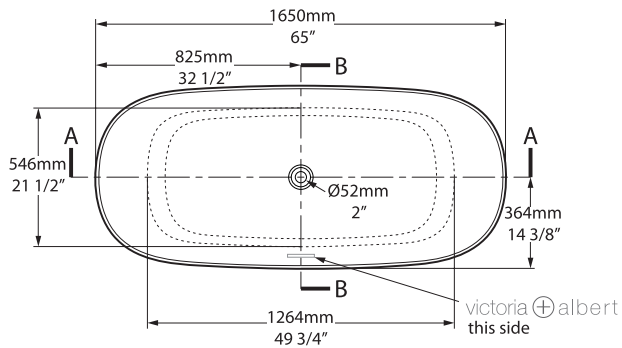

Front view

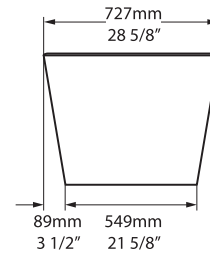

Side view

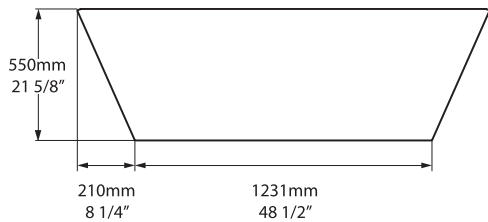

Section BB Shown with K51 waste kit

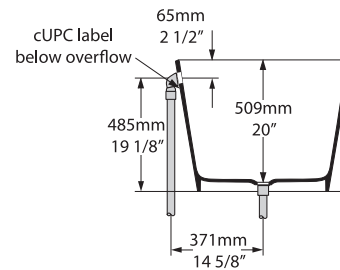

Section AA

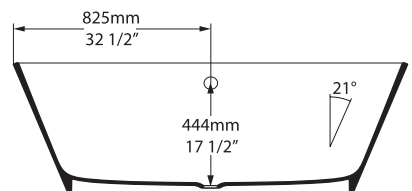

*All measurements subject to +/-5% tolerance

l = 1650mm / 65"
w = 727mm / 28 5/8"
h = 550mm / 21 5/8"

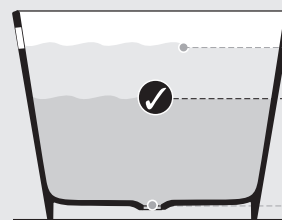
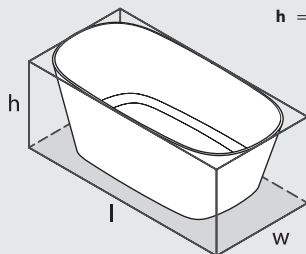

- 891 88 1/2 US gal
- 509 42 3/4 US gal
- 152 0 US gal



.dwg | .dxf | .skp www.vandabaths.com



Massachusetts Code: Approved
cUPC listing by IAPMO: File No. 6574



VA/1181/06/Feb19